

Arceaux cycles **RENFORCÉS**

CARACTÉRISTIQUES TECHNIQUES

- > Tube acier Ø 50 mm
- > Longueur 700 mm
- > Hauteur hors sol 850 mm

RECOMMANDATIONS DE POSE

- > Fixation par scellement direct







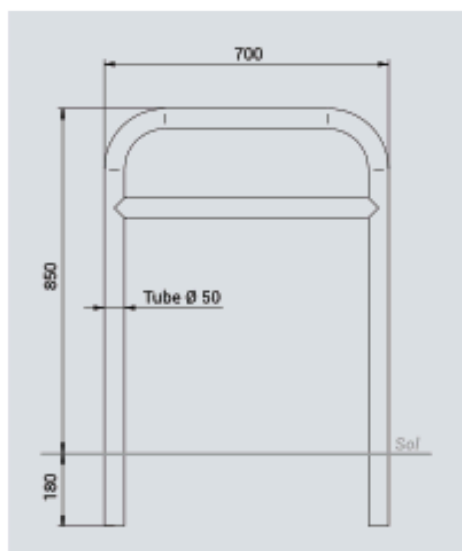





RÉFÉRENCES

Galva	204011
Peint	204012



FINITION PEINTURE

- > Finition galva ou peint sur galva selon nos coloris

					
RAL 3020	RAL 3004	RAL 5010	RAL 6005	RAL 8017	Galva
					
RAL 7044	RAL 9010	RAL 9005	Gris PROCITY*	Aspect Corten	